

User manual

IP Strobe M



This product manual contains important information about the safe installation and use of the light. Please read and follow these instructions carefully and keep this manual in a safe place for future reference.

Content

Safety instructions	3
Installation	4
Signal and power connection	5
Function setting	6
DMX address setting	6
OPERATION DISPLAY	7
DMX Channel	9
Maintenance	12
Trouble shooting	12
Technical Data	13

Every unit is tested completely and packed properly by the manufacturer. Please make sure the packing and / or the unit are in good condition before installation and use. Should there be any damage caused by transportation, consult your dealer and do not use the unit. Any damage caused by improper use will not be assumed by the manufacturer and / or dealer.

Please note that as part of our ongoing commitment to continuous product development, specifications are subject to change without notice.

ACCESSORIES

These items are packed together with the light.:

Name	Quantity	Unit	Remarks
clamps	2	Pcs	
Safety cord	2	Pcs	
Using manual	1	Pcs	

Safety instructions

When unpacking and before disposing of the carton check there is no transportation damage before using the light. Should there be any damage caused by transportation, consult your dealer and do not use the apparatus.

The projector is for indoor and outdoor use, IP65.

Do not install the fixtures onto inflammable surfaces directly.



The fixture is only intended for installation, operation and maintenance by qualified personnel.

Do not project the beam onto inflammable surfaces, minimum distance is 3meter. \sphericalangle
3m E

Avoid direct exposure to the light from the lamp. The light is harmful to the eye.

Do not attempt to dismantle and/or modify the projector in any way.

Electrical connection must only be carried out by qualified personnel.

Before installation, ensure that the voltage and frequency of power supply match the power requirements of the fixture.

It is essential that each projector is correctly earthed and that electrical installation conforms to all relevant standards.

Do not connect this device to any other types of dimmer apparatus.

The projector should always be installed with a secondary safety fixing. A safety cord is supplied for this; it should be attached as shown in "installing the projector" section.

Shields and lens shall be changed if they have become visibly damaged to such an extent than their effectiveness is impaired, for

example by cracks or deep scratches.

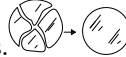

Exterior surface temperatures of the luminaire after 5 minutes operation is 45°C, when steady state is achieved 70°C

There is no user serviceable parts inside the projector, do not open the housing and never operate the fixture with the covers removed.

If you have any questions, don't hesitate to consult your dealer or manufacturer.

Always disconnection from Power before the device's installation, cleaning and maintenance!

INSTALLATIONS

Product Overview

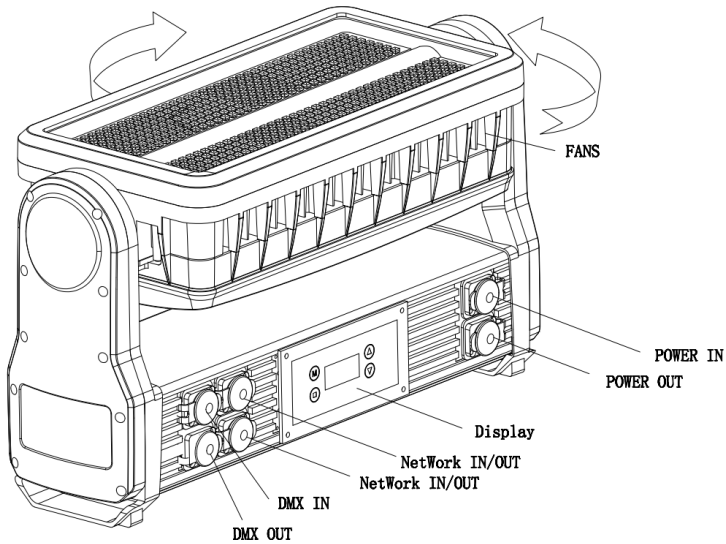

Product Dimensions

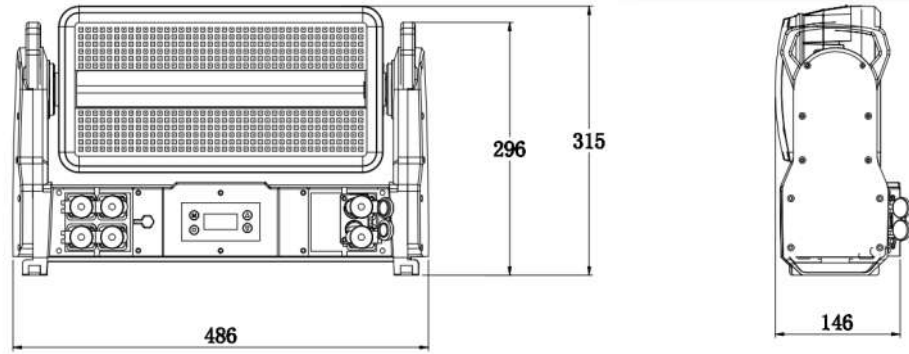

Safety Informations



WARNING! Read the safety precautions in this section before unpacking, installing, powering or operating this product.

This luminaries are multi-environmental fixtures with an IP-rating of 65, intended for professional use only. They are not suitable for household use.

Review the following safety precautions carefully before installing or operating the fixture. This fixture must be installed in accordance with the applicable installation code by a person familiar with the construction and operation of the fixture and the hazards involved.

Preventing electric shock



WARNING! Risk of electric shock.

- Always power off/unplug the fixture before removing any covers.
- Ensure that the power is turned off when connecting the fixture to the AC mains supply.
- Ensure that the fixture is electrically connected to earth (ground).
- Do not apply power if the fixture is in any way damaged.
- Do not immerse the fixture in water or liquid.

Preventing burns and fire



WARNING! Take measures to prevent burns and fire.

- Install in a location that prevents accidental contact with the fixture.
- Install only in a well-ventilated space.
- Install at least 0.3 m (12 in.) away from objects to be illuminated.
- Install only in accordance with applicable building codes.
- Ensure a minimum clearance of 0.1 m (4 in.) around the cooling fans.
- Do not paint, cover or modify the fixture.
- Keep all flammable materials away from the fixture.
- Allow the fixture to cool for 15 minutes after operation, before touching it.
- CAUTION: Exterior surface temperature after 5 min. operation = 45 °C (113 °F). Steady state = 60 °C (140 °F).

Avoid personal injury



WARNING! Take measure to prevent personal injury.

- Do not look directly at the light source from close range.
- Take precautions to prevent injury due to falls when working at height.
- For permanent installation, ensure that the fixture is securely fastened to a load-bearing surface with suitable corrosion-resistant hardware.
- For temporary installation with clamps, ensure that the quarter-turn fasteners are turned fully and secured with a suitable safety cable. The cable must be approved for a safe working load (SWL) of 10 times the weight of the fixture, and it must have a minimum gauge of 3 mm.

Preparing for installation

Unpack the fixture and inspect it to ensure that it has not been damaged during transport.

The fixture is shipped with two quarter-turn brackets, that can be used to mount the fixture at elevation.

The fixture is IP65-rated, and is designed for use in wet locations. This means that it is protected from:

- Dust, to the degree that dust cannot enter the fixture in sufficient quantities as to interfere with its operation.
- Lower pressure jets of water from any direction.

When selecting a location for the fixture, ensure that:

- It is situated away from public thoroughfares and protected from contact with people.
- It is not immersed in water or exposed to high-pressure water jets.
- It has adequate ventilation.

Installation

The fixture may be installed in any orientation, but if installed horizontally with a downward beam-angle, water can potentially pool in the fan wells. Under normal operation the moisture will evaporate. However, in locations with high rainfall, you may wish to fabricate a rain shield above the fixture, or modify the position and orientation of the fixture to minimize pooling.

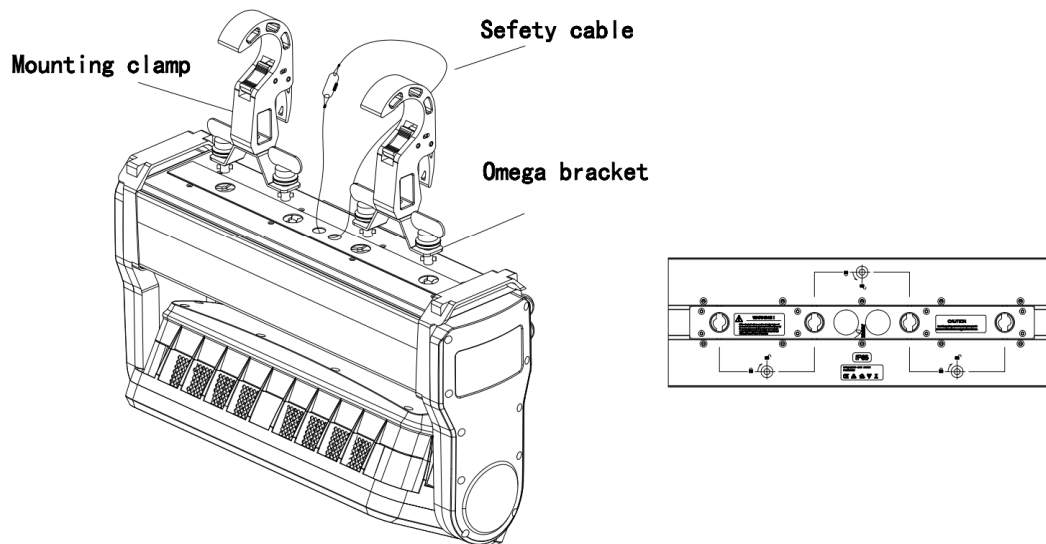

Two quarter-turn brackets are supplied with the fixture if it is to be flown above the ground. Rig the fixture to a support truss or structure using the supplied brackets and suitable clamps.

Fasten a safety cable (not shown) between the support structure and the attachment point on the fixture. The safety cable must be able to bear at least 10 times the weight of the fixture.

Connecting AC Power

The fixture can operate on any 100–240 V, 50/60 Hz AC mains power supply. It draws approximately 2 amps at full power. For permanent installation, have a qualified electrician wire the mains cable directly to a suitable branch circuit. The junction's ingress protection (IP) rating must be suitable for the location. For temporary installation, the mains cable may be fitted with a grounded connector intended for exterior use.

When installing standard type C circuit breakers there will be no limitations due to the fixture in-rush current. Due to the nominal current of the fixture, ensure that no more than:

4 fixtures are connected through the same type C, 10A circuit breaker. 7

fixtures are connected through the same type C, 16A circuit breaker.

The fixture must be grounded/earthed and be able to be isolated from AC power. The AC power supply must incorporate a fuse or circuit breaker for fault protection.

After connecting the fixture to power, run the on-board test, using the "Fixture Test" menu, to ensure that the fixture and each LED are functioning correctly. See "Control menu" on page 13.

CAUTION: Do not open the fixture to replace the supplied power cable, or connect the fixture to an electrical dimmer system, as this can damage i

Configuring the fixture

Set up the fixture using the control panel and LCD display at the arm side of the fixture.

Navigate the menus and options using the arrow buttons and select items using the Enter button. The options available are listed in "Control menu" on page 13. After powering on, the display shows the currently selected operating mode and other information.

The fixture is set by default to be controlled in DMX mode.

Master/Slave configuration

You can set a fixture to operate as master fixture to another fixture (which then becomes a slave fixture), or an entire group of fixtures (which then becomes slave fixtures). The assigned slave fixture(s) will mimic the settings of the master fixture. Use the "Auto Program -> Auto Color / Auto Fade" menu to set your fixture as master fixture, then other fixtures set to DMX mode as slave fixture.

Setting a static color manually

The fixture can be configured to display a predefined and static color using the "Manual Color" (see "Control menu" on page 13).

It may suit your needs when you without a DMX controller to do the color mixing.

Using stand-alone operation

Stand-alone operation is where the fixture is not connected to a control device, but is preprogrammed with 2 modes (Auto Color, Auto Fade), that play continuously in a loop, the run speed of "Auto Color", "Auto Fade" are adjustable. To define a stand-alone program, use the "Auto Program" menus (see "Control menu" on page 13).

Connecting to a DMX control device

The fixture is controllable using a DMX control device and it can be connected using a DMX cable.

If using a cabled DMX system, connect the DMX in cable (with male 3-pin XLR plug) and out cable (with female 3-pin XLR plug) to the DMX data link.

Terminate the DMX out cable of the last fixture in the data link. For outdoor installations, use only IP-rated XLR connectors suitable for outdoor use.

The DMX512 is widely used in intelligent lighting control, with a DMX 512 controller. connect several lights together, DMX in and DMX out, 3 pin XLR connectors: Pin 1: GND, Pin 2: Negative signal (-), Pin 3: Positive signal (+)

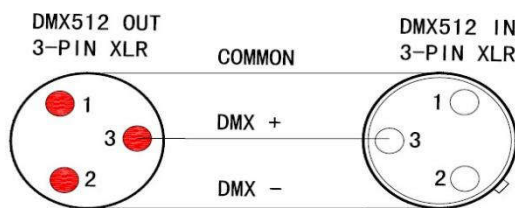
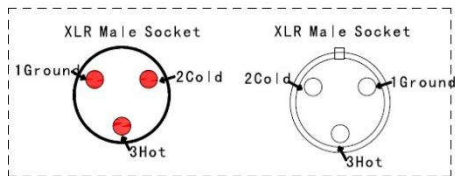

Figure2



XLR Pin Configuration
pin1=Ground
pin2=Data Compliment (negative)
pin3=Data true (positive)

Configuring the fixture for DMX control

About DMX

The fixture can be controlled using signals sent by a DMX controller on a number of channels (which varies depending on the DMX mode that has been set).

The first channel used to receive data from a DMX control device is known as the DMX start address. Each fixture must have a DMX start address set. For example, if a fixture has a DMX address of 10 and it is in 4-channel DMX mode, then it uses channels 10, 11, 12 and 13. The following fixture in the DMX chain could then be set to a DMX address of 14. If two or more DMX fixtures of the same type have the same DMX address, then they will mimic each other's behaviour. Incorrect settings will result in unpredictable responses to the lighting controller.

Setting the DMX address

The DMX address can be seen on the main screen. To change the address setting, press the up arrow to increase the address, or the down arrow to decrease the setting. When the desired address is displayed, press Enter to save the setting.

Note that channel spacing is determined by the DMX mode.

See the "DMX protocols" on page 11 for specific DMX control values.

Setting the DMX mode

Using the "DMX Channel Mode" menu available from the control panel, specify the DMX mode that provides the fixture controls that you require, confirm chosen mode by pressing 'Enter'.

Cleaning

To maintain optimal performance, regular cleaning is essential. Cleaning schedules will vary depending on the operating environment, and the installation should therefore be checked at frequent intervals within the first few weeks of operation to see whether cleaning is necessary. This procedure will allow you to assess cleaning requirements in your particular situation. Clean the fixture using a soft cloth dampened with a solution of water and a mild detergent. Do not use products that contain solvents, abrasives or caustic agents for cleaning, as they can cause damage to both hardware, cables and connectors.

DMX protocols

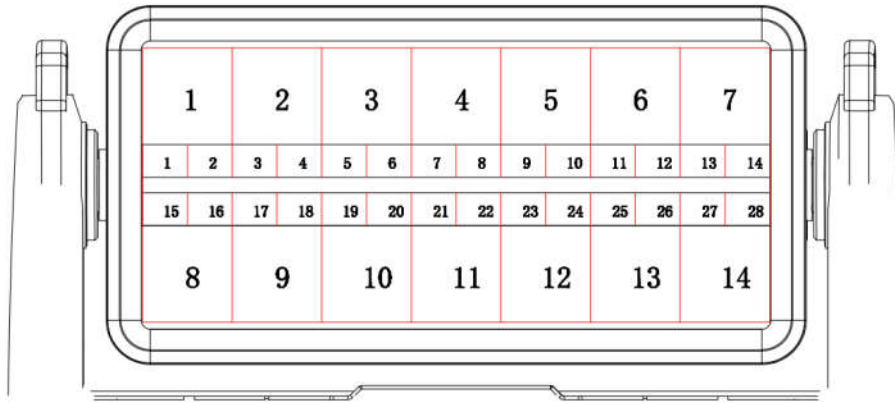

8CH

Channel	Function	Value	Percent/Setting
1	Tilt	000 ⇄ 255	0–100%
2	Fine tilt	000 ⇄ 255	0–100%
3	Dimmer	000 ⇄ 255	0–100%
4	Strobe	000 ⇄ 009	Open
		010 ⇄ 079	Strobe, slow to fast
		080 ⇄ 149	Pulse, slow to fast
		150 ⇄ 219	Random strobe, slow to fast
4	Strobe	220 ⇄ 255	Open
5	Red	000 ⇄ 255	0–100%
6	Green	000 ⇄ 255	0–100%
7	Blue	000 ⇄ 255	0–100%
8	Beam	000 ⇄ 255	0–100%

11CH

Channel	Function	Value	Percent/Setting
1	Tilt	000 ⇄ 255	0–100%
2	Fine tilt	000 ⇄ 255	0–100%
3	Dimmer	000 ⇄ 255	0–100%
4	Plate flash duration	000 ⇄ 009	Classic shutter mode: disables duration control
		010 ⇄ 250	Slow to fast
		251 ⇄ 255	100% On, no flash/strobe
5	Plate flash rate	000 ⇄ 009	100%
		010 ⇄ 250	Slow to fast
		251 ⇄ 255	100%
6	Beam flash duration	000 ⇄ 009	Classic shutter mode: disables duration control
		010 ⇄ 250	Slow to fast
		251 ⇄ 255	100% On, no flash/strobe
7	Beam flash rate	000 ⇄ 009	100%
		010 ⇄ 250	Slow to fast
		251 ⇄ 255	100% on
8	Plates red	000 ⇄ 255	0–100%
9	Plates green	000 ⇄ 255	0–100%
10	Plates blue	000 ⇄ 255	0–100%
11	Beam	000 ⇄ 255	0–100%

13CH

Channel	Function	Value	Percent/Setting
1	Tilt	000 ⇄ 255	0–100%
2	Fine tilt	000 ⇄ 255	0–100%
3	Plate dimmer	000 ⇄ 255	0–100%
4	Beam dimmer	000 ⇄ 255	0–100%
5	Plate flash duration	000 ⇄ 009	Classic shutter mode: disables duration control
		010 ⇄ 250	Slow to fast
		251 ⇄ 255	100% On, no flash/strobe
6	Plate flash rate	000 ⇄ 009	100%
		010 ⇄ 250	Slow to fast
		251 ⇄ 255	100%
7	Beam flash duration	000 ⇄ 009	Classic shutter mode: disables duration control
		010 ⇄ 250	Slow to fast
		251 ⇄ 255	100% On, no flash/strobe
8	Beam flash rate	000 ⇄ 009	100%
		010 ⇄ 250	Slow to fast
		251 ⇄ 255	100% on

Channel	Function	Value	Percent/Setting
9	Plates red	000 ⇄ 255	0–100%
10	Plates green	000 ⇄ 255	0–100%
11	Plates blue	000 ⇄ 255	0–100%
12	Beam FX	000 ⇄ 005	No function
		006 ⇄ 042	Ramp up
		043 ⇄ 085	Ramp down
		086 ⇄ 128	Ramp up-down
		129 ⇄ 171	Random
		172 ⇄ 214	Lightning
		215 ⇄ 255	Spikes
13	Control*	000 ⇄ 005	No function
		006 ⇄ 010	Off (dimmer mode)
		011 ⇄ 015	Dimmer 1 (dimmer mode)
		016 ⇄ 020	Dimmer 2 (dimmer mode)
		021 ⇄ 025	Dimmer 3 (dimmer mode)
		026 ⇄ 030	600 Hz
		031 ⇄ 035	1200 Hz
		036 ⇄ 040	2000 Hz
		041 ⇄ 045	4000 Hz
		046 ⇄ 050	6000 Hz
		051 ⇄ 055	25 KHz
		056 ⇄ 060	Fan mode auto
		061 ⇄ 065	Fan mode on
		066 ⇄ 070	Tilt reset
		071 ⇄ 075	Plate 1 invert off
		076 ⇄ 080	Plate 1 invert on
		081 ⇄ 085	Plate 2 invert off
		086 ⇄ 090	Plate 2 invert on
		091 ⇄ 095	Beam 1 invert off
		096 ⇄ 100	Beam 1 invert on
		101 ⇄ 105	Beam 2 invert off
		106 ⇄ 110	Beam 2 invert on
		111 ⇄ 115	Plate swap on
116 ⇄ 120	Plate swap off		
121 ⇄ 125	Beam swap on		
126 ⇄ 130	Beam swap off		
		131 ⇄ 255	No function

24CH

Channel	Function	Value	Percent/Setting
1	Tilt	000 ⇄ 255	0–100%
2	Fine tilt	000 ⇄ 255	0–100%
3	Master dimmer	000 ⇄ 255	0–100%
4	Plate dimmer	000 ⇄ 255	0–100%
5	Beam dimmer	000 ⇄ 255	0–100%
6	Plate flash duration	000 ⇄ 009	Classic shutter mode: disables duration control
		010 ⇄ 250	Slow to fast
		251 ⇄ 255	100% On, no flash/strobe
7	Plate flash rate	000 ⇄ 009	100%
		010 ⇄ 250	Slow to fast
		251 ⇄ 255	100%
8	Beam flash duration	000 ⇄ 009	Classic shutter mode: disables duration control
		010 ⇄ 250	Slow to fast
		251 ⇄ 255	100% On, no flash/strobe
9	Beam flash rate	000 ⇄ 009	100%
		010 ⇄ 250	Slow to fast
		251 ⇄ 255	100% on
10	Plates red	000 ⇄ 255	0–100%
11	Plates green	000 ⇄ 255	0–100%
12	Plates blue	000 ⇄ 255	0–100%
13	Beam FX	000 ⇄ 005	No function
		006 ⇄ 042	Ramp up
		043 ⇄ 085	Ramp down
		086 ⇄ 128	Ramp up-down
		129 ⇄ 171	Random
		172 ⇄ 214	Lightning
		215 ⇄ 255	Spikes
14	Plates foreground	000 ⇄ 000	No function
		001 ⇄ 002	White (2700K)
		003 ⇄ 004	White (3200K)
		005 ⇄ 006	White (4200K)
		007 ⇄ 008	White (5600K)
		009 ⇄ 010	White (8000K)
		011	Blue R: 0 G: 0 B: 255 W: 0
		012 ⇄ 048	Green+ / Blue R: 0 G: + B: 255 W: 0
		049	Cyan R: 0 G: 255 B: 255 W: 0
		050 ⇄ 086	Green / Blue- R: 0 G: 255 B: - W: 0
		087	Green R: 0 G: 255 B: 0 W: 0
		088 ⇄ 124	Red+ / Green R: + G: 255 B: 0 W: 0
		125	Yellow R: 255 G: 255 B: 0 W: 0
		126 ⇄ 162	Red / Green- R: 255 G: - B: 0 W: 0
		163	Red R: 255 G: 0 B: 0 W: 0
		164 ⇄ 200	Red / Blue+ R: 255 G: 0 B: + W: 0
		201	Magenta R: 255 G: 0 B: 255 W: 0
202 ⇄ 238	Red- / Blue R: - G: 0 B: 255 W: 0		
239	Blue R: 0 G: 0 B: 255 W: 0		
240 ⇄ 247	Color index, fast to slow		
248 ⇄ 255	Color snap, fast to slow		

Channel	Function	Value	Percent/Setting
15	Plates foreground dimmer	000 ⇔ 255	0–100%
16	Plates background	000 ⇔ 000	No function
		001 ⇔ 002	White (2700K)
		003 ⇔ 004	White (3200K)
		005 ⇔ 006	White (4200K)
		007 ⇔ 008	White (5600K)
		009 ⇔ 010	White (8000K)
		011	Blue R: 0 G: 0 B: 255 W: 0
		012 ⇔ 048	Green+ / Blue R: 0 G: + B: 255 W: 0
		049	Cyan R: 0 G: 255 B: 255 W: 0
		050 ⇔ 086	Green / Blue- R: 0 G: 255 B: - W: 0
		087	Green R: 0 G: 255 B: 0 W: 0
		088 ⇔ 124	Red+ / Green R: + G: 255 B: 0 W: 0
		125	Yellow R: 255 G: 255 B: 0 W: 0
		126 ⇔ 162	Red / Green- R: 255 G: - B: 0 W: 0
		163	Red R: 255 G: 0 B: 0 W: 0
		164 ⇔ 200	Red / Blue+ R: 255 G: 0 B: + W: 0
		201	Magenta R: 255 G: 0 B: 255 W: 0
		202 ⇔ 238	Red- / Blue R: - G: 0 B: 255 W: 0
		239	Blue R: 0 G: 0 B: 255 W: 0
		240 ⇔ 247	Color index, fast to slow
248 ⇔ 255	Color snap, fast to slow		
17	Plates background dimmer	000 ⇔ 255	0–100%
18	Plates 1 & 2 FX select (see Pixel Mapping)	000 ⇔ 002	Plate FX All select (all on)
		003 ⇔ 255	see Plate Patterns
19	Plates 1 & 2 FX movement speed & direction (see Pixel Mapping)	000 ⇔ 005	No function
		006 ⇔ 124	Left to right, fast to slow
		125 ⇔ 130	No function
		131 ⇔ 249	Right to left, slow to fast
		250 ⇔ 255	No function
20	Plates 1 & 2 FX crossfade (see Pixel Mapping)	000 ⇔ 002	Snap from cell to cell
		003 ⇔ 255	Fade duration: short to long
21	Beams 1 & 2 FX select	000 ⇔ 002	Beam FX All select (all on)
		003 ⇔ 255	see Beam Patterns
22	Beams 1 & 2 FX movement speed & direction (see Pixel Mapping)	000 ⇔ 005	No function
		006 ⇔ 124	Left to right, fast to slow
		125 ⇔ 130	No function
		131 ⇔ 249	Right to left, slow to fast
		250 ⇔ 255	No function
23	Beams 1 & 2 FX crossfade (see Pixel Mapping)	000 ⇔ 002	Snap from cell to cell
		003 ⇔ 255	Fade duration: short to long

Channel	Function	Value	Percent/Setting
24	Control*	000 ⇄ 005	No function
		006 ⇄ 010	Off (dimmer mode)
		011 ⇄ 015	Dimmer 1
		016 ⇄ 020	Dimmer 2
		021 ⇄ 025	Dimmer 3
		026 ⇄ 030	600 Hz
		031 ⇄ 035	1200 Hz
		036 ⇄ 040	2000 Hz
		041 ⇄ 045	4000 Hz
		046 ⇄ 050	6000 Hz
		051 ⇄ 055	25 KHz
		056 ⇄ 060	Fan mode auto
		061 ⇄ 065	Fan mode on
		066 ⇄ 070	Tilt reset
		071 ⇄ 075	Plate1 invert off
		076 ⇄ 080	Plate1 invert on
		081 ⇄ 085	Plate2 invert off
		086 ⇄ 090	Plate2 invert on
		091 ⇄ 095	Beam1 invert off
		096 ⇄ 100	Beam1 invert on
		101 ⇄ 105	Beam2 invert off
		106 ⇄ 110	Beam2 invert on
		111 ⇄ 115	Plate swap on
		116 ⇄ 120	Plate swap off
121 ⇄ 125	Beam swap on		
126 ⇄ 130	Beam swap off		
131 ⇄ 255	No function		

74CH

Channel	Function	Value	Percent/Setting
1	Tilt	000 ⇄ 255	0–100%
2	Fine tilt	000 ⇄ 255	0–100%
3	Dimmer	000 ⇄ 255	0–100%
4	Strobe	000 ⇄ 009	Open
		010 ⇄ 079	Strobe, slow to fast
		080 ⇄ 149	Pulse, slow to fast
		150 ⇄ 219	Random strobe, slow to fast
		220 ⇄ 255	Open
5	Plate pixel 1 red	000 ⇄ 255	0–100%
6	Plate pixel 1 green	000 ⇄ 255	0–100%
7	Plate pixel 1 blue	000 ⇄ 255	0–100%
8	Plate pixel 2 red	000 ⇄ 255	0–100%
9	Plate pixel 2 green	000 ⇄ 255	0–100%
10	Plate pixel 2 blue	000 ⇄ 255	0–100%
11	Plate pixel 3 red	000 ⇄ 255	0–100%
12	Plate pixel 3 green	000 ⇄ 255	0–100%
13	Plate pixel 3 blue	000 ⇄ 255	0–100%
14	Plate pixel 4 red	000 ⇄ 255	0–100%
15	Plate pixel 4 green	000 ⇄ 255	0–100%
16	Plate pixel 4 blue	000 ⇄ 255	0–100%
17	Plate pixel 5 red	000 ⇄ 255	0–100%
18	Plate pixel 5 green	000 ⇄ 255	0–100%
19	Plate pixel 5 blue	000 ⇄ 255	0–100%
20	Plate pixel 6 red	000 ⇄ 255	0–100%
21	Plate pixel 6 green	000 ⇄ 255	0–100%
22	Plate pixel 6 blue	000 ⇄ 255	0–100%
23	Plate pixel 7 red	000 ⇄ 255	0–100%
24	Plate pixel 7 green	000 ⇄ 255	0–100%
25	Plate pixel 7 blue	000 ⇄ 255	0–100%
26	Plate pixel 8 red	000 ⇄ 255	0–100%
27	Plate pixel 8 green	000 ⇄ 255	0–100%
28	Plate pixel 8 blue	000 ⇄ 255	0–100%
29	Plate pixel 9 red	000 ⇄ 255	0–100%
30	Plate pixel 9 green	000 ⇄ 255	0–100%
31	Plate pixel 9 blue	000 ⇄ 255	0–100%
32	Plate pixel 10 red	000 ⇄ 255	0–100%
33	Plate pixel 10 green	000 ⇄ 255	0–100%
34	Plate pixel 10 blue	000 ⇄ 255	0–100%
35	Plate pixel 11 red	000 ⇄ 255	0–100%
36	Plate pixel 11 green	000 ⇄ 255	0–100%
37	Plate pixel 11 blue	000 ⇄ 255	0–100%
38	Plate pixel 12 red	000 ⇄ 255	0–100%
39	Plate pixel 12 green	000 ⇄ 255	0–100%
40	Plate pixel 12 blue	000 ⇄ 255	0–100%
41	Plate pixel 13 red	000 ⇄ 255	0–100%
42	Plate pixel 13 green	000 ⇄ 255	0–100%
43	Plate pixel 13 blue	000 ⇄ 255	0–100%
44	Plate pixel 14 red	000 ⇄ 255	0–100%

Channel	Function	Value	Percent/Setting
45	Plate pixel 14 green	000 ⇄ 255	0-100%
46	Plate pixel 14 blue	000 ⇄ 255	0-100%
47	Beam pixel 1	000 ⇄ 255	0-100%
48	Beam pixel 2	000 ⇄ 255	0-100%
49	Beam pixel 3	000 ⇄ 255	0-100%
50	Beam pixel 4	000 ⇄ 255	0-100%
51	Beam pixel 5	000 ⇄ 255	0-100%
52	Beam pixel 6	000 ⇄ 255	0-100%
53	Beam pixel 7	000 ⇄ 255	0-100%
54	Beam pixel 8	000 ⇄ 255	0-100%
55	Beam pixel 9	000 ⇄ 255	0-100%
56	Beam pixel 10	000 ⇄ 255	0-100%
57	Beam pixel 11	000 ⇄ 255	0-100%
58	Beam pixel 12	000 ⇄ 255	0-100%
59	Beam pixel 13	000 ⇄ 255	0-100%
60	Beam pixel 14	000 ⇄ 255	0-100%
61	Beam pixel 15	000 ⇄ 255	0-100%
62	Beam pixel 16	000 ⇄ 255	0-100%
63	Beam pixel 17	000 ⇄ 255	0-100%
64	Beam pixel 18	000 ⇄ 255	0-100%
65	Beam pixel 19	000 ⇄ 255	0-100%
66	Beam pixel 20	000 ⇄ 255	0-100%
67	Beam pixel 21	000 ⇄ 255	0-100%
68	Beam pixel 22	000 ⇄ 255	0-100%
69	Beam pixel 23	000 ⇄ 255	0-100%
70	Beam pixel 24	000 ⇄ 255	0-100%
71	Beam pixel 25	000 ⇄ 255	0-100%
72	Beam pixel 26	000 ⇄ 255	0-100%
73	Beam pixel 27	000 ⇄ 255	0-100%
74	Beam pixel 28	000 ⇄ 255	0-100%

97CH

Channel	Function	Value	Percent/Setting
1	Tilt	000 ⇄ 255	0–100%
2	Fine tilt	000 ⇄ 255	0–100%
3	Master dimmer	000 ⇄ 255	0–100%
4	Plate dimmer	000 ⇄ 255	0–100%
5	Beam dimmer	000 ⇄ 255	0–100%
6	Plate flash duration	000 ⇄ 009	Classic shutter mode: disables duration control
		010 ⇄ 250	Slow to fast
		251 ⇄ 255	100% On, no flash/strobe
7	Plate flash rate	000 ⇄ 009	100%
		010 ⇄ 250	Slow to fast
		251 ⇄ 255	100%
8	Beam flash duration	000 ⇄ 009	Classic shutter mode: disables duration control
		010 ⇄ 250	Slow to fast
		251 ⇄ 255	100% On, no flash/strobe
9	Beam flash rate	000 ⇄ 009	100%
		010 ⇄ 250	Slow to fast
		251 ⇄ 255	100% on
10	Plate pixel 1 red	000 ⇄ 255	0–100%
11	Plate pixel 1 green	000 ⇄ 255	0–100%
12	Plate pixel 1 blue	000 ⇄ 255	0–100%
13	Plate pixel 2 red	000 ⇄ 255	0–100%
14	Plate pixel 2 green	000 ⇄ 255	0–100%
15	Plate pixel 2 blue	000 ⇄ 255	0–100%
16	Plate pixel 3 red	000 ⇄ 255	0–100%
17	Plate pixel 3 green	000 ⇄ 255	0–100%
18	Plate pixel 3 blue	000 ⇄ 255	0–100%
19	Plate pixel 4 red	000 ⇄ 255	0–100%
20	Plate pixel 4 green	000 ⇄ 255	0–100%
21	Plate pixel 4 blue	000 ⇄ 255	0–100%
22	Plate pixel 5 red	000 ⇄ 255	0–100%
23	Plate pixel 5 green	000 ⇄ 255	0–100%
24	Plate pixel 5 blue	000 ⇄ 255	0–100%
25	Plate pixel 6 red	000 ⇄ 255	0–100%
26	Plate pixel 6 green	000 ⇄ 255	0–100%
27	Plate pixel 6 blue	000 ⇄ 255	0–100%
28	Plate pixel 7 red	000 ⇄ 255	0–100%
29	Plate pixel 7 green	000 ⇄ 255	0–100%
30	Plate pixel 7 blue	000 ⇄ 255	0–100%
31	Plate pixel 8 red	000 ⇄ 255	0–100%
32	Plate pixel 8 green	000 ⇄ 255	0–100%
33	Plate pixel 8 blue	000 ⇄ 255	0–100%
34	Plate pixel 9 red	000 ⇄ 255	0–100%
35	Plate pixel 9 green	000 ⇄ 255	0–100%
36	Plate pixel 9 blue	000 ⇄ 255	0–100%
37	Plate pixel 10 red	000 ⇄ 255	0–100%
38	Plate pixel 10 green	000 ⇄ 255	0–100%
39	Plate pixel 10 blue	000 ⇄ 255	0–100%

Channel	Function	Value	Percent/Setting
40	Plate pixel 11 red	000 ⇄ 255	0–100%
41	Plate pixel 11 green	000 ⇄ 255	0–100%
42	Plate pixel 11 blue	000 ⇄ 255	0–100%
43	Plate pixel 12 red	000 ⇄ 255	0–100%
44	Plate pixel 12 green	000 ⇄ 255	0–100%
45	Plate pixel 12 blue	000 ⇄ 255	0–100%
46	Plate pixel 13 red	000 ⇄ 255	0–100%
47	Plate pixel 13 green	000 ⇄ 255	0–100%
48	Plate pixel 13 blue	000 ⇄ 255	0–100%
49	Plate pixel 14 red	000 ⇄ 255	0–100%
50	Plate pixel 14 green	000 ⇄ 255	0–100%
51	Plate pixel 14 blue	000 ⇄ 255	0–100%
52	Beam pixel 1	000 ⇄ 255	0–100%
53	Beam pixel 2	000 ⇄ 255	0–100%
54	Beam pixel 3	000 ⇄ 255	0–100%
55	Beam pixel 4	000 ⇄ 255	0–100%
56	Beam pixel 5	000 ⇄ 255	0–100%
57	Beam pixel 6	000 ⇄ 255	0–100%
58	Beam pixel 7	000 ⇄ 255	0–100%
59	Beam pixel 8	000 ⇄ 255	0–100%
60	Beam pixel 9	000 ⇄ 255	0–100%
61	Beam pixel 10	000 ⇄ 255	0–100%
62	Beam pixel 11	000 ⇄ 255	0–100%
63	Beam pixel 12	000 ⇄ 255	0–100%
64	Beam pixel 13	000 ⇄ 255	0–100%
65	Beam pixel 14	000 ⇄ 255	0–100%
66	Beam pixel 15	000 ⇄ 255	0–100%
67	Beam pixel 16	000 ⇄ 255	0–100%
68	Beam pixel 17	000 ⇄ 255	0–100%
69	Beam pixel 18	000 ⇄ 255	0–100%
70	Beam pixel 19	000 ⇄ 255	0–100%
71	Beam pixel 20	000 ⇄ 255	0–100%
72	Beam pixel 21	000 ⇄ 255	0–100%
73	Beam pixel 22	000 ⇄ 255	0–100%
74	Beam pixel 23	000 ⇄ 255	0–100%
75	Beam pixel 24	000 ⇄ 255	0–100%
76	Beam pixel 25	000 ⇄ 255	0–100%
77	Beam pixel 26	000 ⇄ 255	0–100%
78	Beam pixel 27	000 ⇄ 255	0–100%
79	Beam pixel 28	000 ⇄ 255	0–100%
80	Beam FX	000 ⇄ 005	No function
		006 ⇄ 042	Ramp up
		043 ⇄ 085	Ramp down
		086 ⇄ 128	Ramp up-down
		129 ⇄ 171	Random
		172 ⇄ 214	Lightning
		215 ⇄ 255	Spikes

Channel	Function	Value	Percent/Setting
81	Plates foreground	000 ⇔ 000	No function
		001 ⇔ 002	White (2700K)
		003 ⇔ 004	White (3200K)
		005 ⇔ 006	White (4200K)
		007 ⇔ 008	White (5600K)
		009 ⇔ 010	White (8000K)
		011	Blue R: 0 G: 0 B: 255 W: 0
		012 ⇔ 048	Green+ / Blue R: 0 G: + B: 255 W: 0
		049	Cyan R: 0 G: 255 B: 255 W: 0
		050 ⇔ 086	Green / Blue- R: 0 G: 255 B: - W: 0
		087	Green R: 0 G: 255 B: 0 W: 0
		088 ⇔ 124	Red+ / Green R: + G: 255 B: 0 W: 0
		125	Yellow R: 255 G: 255 B: 0 W: 0
		126 ⇔ 162	Red / Green- R: 255 G: - B: 0 W: 0
		163	Red R: 255 G: 0 B: 0 W: 0
		164 ⇔ 200	Red / Blue+ R: 255 G: 0 B: + W: 0
		201	Magenta R: 255 G: 0 B: 255 W: 0
		202 ⇔ 238	Red- / Blue R: - G: 0 B: 255 W: 0
		239	Blue R: 0 G: 0 B: 255 W: 0
		240 ⇔ 247	Color index, fast to slow
248 ⇔ 255	Color snap, fast to slow		
82	Plate foreground dimmer	000 ⇔ 255	0–100%
83	Plates background	000 ⇔ 000	No function
		001 ⇔ 002	White (2700K)
		003 ⇔ 004	White (3200K)
		005 ⇔ 006	White (4200K)
		007 ⇔ 008	White (5600K)
		009 ⇔ 010	White (8000K)
		011	Blue R: 0 G: 0 B: 255 W: 0
		012 ⇔ 048	Green+ / Blue R: 0 G: + B: 255 W: 0
		049	Cyan R: 0 G: 255 B: 255 W: 0
		050 ⇔ 086	Green / Blue- R: 0 G: 255 B: - W: 0
		087	Green R: 0 G: 255 B: 0 W: 0
		088 ⇔ 124	Red+ / Green R: + G: 255 B: 0 W: 0
		125	Yellow R: 255 G: 255 B: 0 W: 0
		126 ⇔ 162	Red / Green- R: 255 G: - B: 0 W: 0
		163	Red R: 255 G: 0 B: 0 W: 0
		164 ⇔ 200	Red / Blue+ R: 255 G: 0 B: + W: 0
		201	Magenta R: 255 G: 0 B: 255 W: 0
		202 ⇔ 238	Red- / Blue R: - G: 0 B: 255 W: 0
		239	Blue R: 0 G: 0 B: 255 W: 0
		240 ⇔ 247	Color index, fast to slow
248 ⇔ 255	Color snap, fast to slow		
84	Plate background dimmer	000 ⇔ 255	0–100%
85	Plate 1 (pixels 1–7) FX select (see Pixel Mapping)	000 ⇔ 002	Plate FX All select (all on)
		003 ⇔ 255	see Plate Patterns

Channel	Function	Value	Percent/Setting
86	Plate 1 (pixels 1–7) FX movement speed & direction (see Pixel Mapping)	000 ⇄ 005	No function
		006 ⇄ 124	Left to right, fast to slow
		125 ⇄ 130	No function
		131 ⇄ 249	Right to left, slow to fast
		250 ⇄ 255	No function
87	Plate 1 (pixels 1–7) FX crossfade (see Pixel Mapping)	000 ⇄ 002	Snap from cell to cell
		003 ⇄ 255	Fade duration: short to long
88	Plate 2 (pixels 8–14) FX select (see Pixel Mapping)	000 ⇄ 002	Plate FX All select (all on)
		003 ⇄ 255	see Plate Patterns
89	Plate 2 (pixels 8–14) FX movement speed & direction (see Pixel Mapping)	000 ⇄ 005	No function
		006 ⇄ 124	Left to right, fast to slow
		125 ⇄ 130	No function
		131 ⇄ 249	Right to left, slow to fast
		250 ⇄ 255	No function
90	Plate 2 (pixels 8–14) FX crossfade (see Pixel Mapping)	000 ⇄ 002	Snap from cell to cell
		003 ⇄ 255	Fade duration: short to long
91	Beam 1 (pixels 1–14) FX select (see Pixel Mapping)	000 ⇄ 002	Beam FX All select (all on)
		003 ⇄ 255	see Beam Patterns
92	Beam 1 (pixels 1–14) FX movement speed & direction (see Pixel Mapping)	000 ⇄ 005	No function
		006 ⇄ 124	Left to right, fast to slow
		125 ⇄ 130	No function
		131 ⇄ 249	Right to left, slow to fast
		250 ⇄ 255	No function
93	Beam 1 (pixels 1–14) FX crossfade (see Pixel Mapping)	000 ⇄ 002	Snap from cell to cell
		003 ⇄ 255	Fade duration: short to long
94	Beam 2 (pixels 15–28) FX select (see Pixel Mapping)	000 ⇄ 002	Beam FX All select (all on)
		003 ⇄ 255	see Beam Patterns
95	Beam 2 (pixels 15–28) FX movement speed & direction (see Pixel Mapping)	000 ⇄ 005	No function
		006 ⇄ 124	Left to right, fast to slow
		125 ⇄ 130	No function
		131 ⇄ 249	Right to left, slow to fast
		250 ⇄ 255	No function
96	Beam 2 (pixels 15–28) FX crossfade (see Pixel Mapping)	000 ⇄ 002	Snap from cell to cell
		003 ⇄ 255	Fade duration: short to long

Channel	Function	Value	Percent/Setting
97	Control*	000 ⇄ 005	No function
		006 ⇄ 010	Off (dimmer mode)
		011 ⇄ 015	Dimmer 1
		016 ⇄ 020	Dimmer 2
		021 ⇄ 025	Dimmer 3
		026 ⇄ 030	600 Hz
		031 ⇄ 035	1200 Hz
		036 ⇄ 040	2000 Hz
		041 ⇄ 045	4000 Hz
		046 ⇄ 050	6000 Hz
		051 ⇄ 055	25 KHz
		056 ⇄ 060	Fan mode auto
		061 ⇄ 065	Fan mode on
		066 ⇄ 070	Tilt reset
		071 ⇄ 075	Plate1 invert off
		076 ⇄ 080	Plate1 invert on
		081 ⇄ 085	Plate2 invert off
		086 ⇄ 090	Plate2 invert on
		091 ⇄ 095	Beam1 invert off
		096 ⇄ 100	Beam1 invert on
		101 ⇄ 105	Beam2 invert off
		106 ⇄ 110	Beam2 invert on
		111 ⇄ 115	Plate swap on
		116 ⇄ 120	Plate swap off
		121 ⇄ 125	Beam swap on
126 ⇄ 130	Beam swap off		
131 ⇄ 255	No function		

14 Channel mode

Channel	Name	DMX Value	Description
1	Tilt	0-255	Tilt Movement
2	Tilt Fine	0-255	Tilt Fine Movement
3	Dimme	0-255	
4	Plate Macro	0-4	Plate Macro Off
		5-9	Plate Macro 1
		10-14	Plate Macro 2
		15-19	Plate Macro 3
		...	Plate Macro ...
		250-254	Plate Macro 50
		255	Plate Macro 51
5	Plate Macro Color	0-255	Plate Macro Color
6	Plate Macro Speed	0-255	Speed From Slow To Fast
7	Beam Macro	0-5	No Strobe
		6-42	Strobe Mode 1
		43-85	Strobe Mode 2
		86-128	Strobe Mode 3
		129-171	Strobe Mode 4
		172-214	Strobe Mode 5
		215-255	Strobe Mode 6
8	Beam Macro speed	0-255	0-255
9	Plate Strobe	0-9	No Strobe
		10-255	Strobe from slow to fast
10	Beam Strobe	0-9	No Strobe
		10-255	Strobe from slow to fast
11	Plate Red	0-255	
12	Plate Green	0-255	
13	Plate Blue	0-255	
14	Beam	0-255	

5 Channel mode-Net

Chan nel	Name	DescriptionDMX	Value
1	Coarse Tilt (MSB)	0- 185°	0-255
2	Fine Tilt (LSB)	Coarse tilt + 0- 1.2°	0-255
3	Beam Intensity	Intensity 0- 100%	0-255
4	Beam Duration	Flash duration 7-650 ms	0-255
5	Beam Shutter	No	
		flash1	6-42
		Flash2	43-85
		Flash3	86-128
		Flash4	129-171
		Flash5	172-214
		Flash6	215-255

Control menu

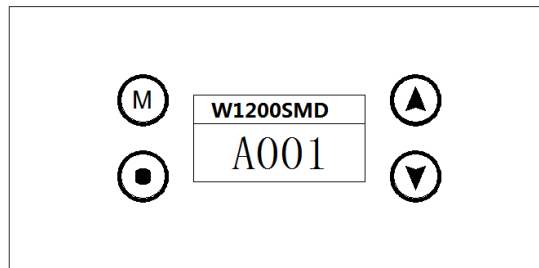

power-on password: **UP** - **DOWN** - **UP** - **DOWN** - **ENTER**

Press button **UP** or **DOWN** if you want to browse through the various Setup Options.

Press button **ENTER** to save your settings or enter the next menu.

Press button **UP** or **DOWN** to shift.

Press button **Menu** will return to the upper menu one by one.

power-on password: - - -

1st LEVEL	2nd LEVEL	1rd LEVEL	1th LEVEL
DMX Address	XXX (1~499)	enter	
Net IP	IP Address	IP (0-255)	Enter
		IP (0-255)	Enter
		IP (0-255)	Enter
		IP (0-255)	Enter
	Sub tmask	255.0.0.0	Enter
		255.255.0.0	Enter
255.255.255.0		Enter	
Set Universe	Strobe Universe	0-32766	Enter
	Aura Universe	0-32766	Enter
Config	DMX channel mode	8 channel mode	
		11 channel mode	
		13 channel mode	
		24 channel mode	
		74 channel mode	
		97 channel mode	
		14 channel mode	
		5 channel mode -NEt	
	OFFLine Show	Manual	
		Fix show	
		User Shou	
	LED HZ	1200	
		2400	
		4800	
Parameter	Yes/No		
Default	Canel / Ok		
Factory Set	000		
Motor	Reset	Canel / Ok	

	Offset	000
	Invert	TILT < >
	Feedback	off
		On
Display	Ch / En	
	Display Dir	Normal
		Reverse
	Backlight	30S
On		
Manual	Tilt	
	Dimmer	
	Strobe	
	macro	
	macroS	
	Red	
	Green	
	Blue	
	White	
Auto	Show RGB	
	Speed RGB	
	Show W	
	Speed W	
	TILT	
Information	RDM UID	
	Version	
	DMX channel	
	Run time	
	Use time	
	Temperature	

12. Specification

Strobe Panel LEDs

LED Type: 5050 0.5W RGB 3in1 LEDs

LED Count: 504

LED Colors: RGB

LED Segments: 14 (2 x 7)

Strobe Tube LEDs

LED Type: 3535 5W 6500K LEDs

LED Count: 392

LED Colors: Cool-White

LED Segments: 28(2x14)

Movement Resolution:
8-16 Bit Position
Feedback: yes Tilt
(Degrees): 185°

Control

Control Modes:8

Display: Illuminated graphic LCD

Protocol: USITT DMX-512, RDM

RDM: Bidirectional communication

Wireless DMX: 2.4 GHz W-DMX™ (optional)

Cooling: Temperature controlled, overheating protection

Effects

Dimmer: 0-100% electronic Shutter:
electronic, max. 20 Hz Internal

Effects: LED Macro Effects

Connectors

Signal connection: Seetronic IP65 XLR 5-Pin or 3-Pin In/Out

Power Input: Seetronic powerCON TRUE1 In/Out

Operating Conditions

Mains voltage: 100-240V AC / 50-60Hz

Power: 1200W

Maximum ambient temperature: -30°C / 86°F, 50°C / 122°F Operating

Position: any

Mounting Options

Standing: Rubber feet

Hanging:

Omega-Bracket

Safety wire attachment: foldout eyelets

Shipping

Single fixture: cardboard (inner and outer cartons)

Tourpack: 4-way Flight Case

Housing Colors

Standard colors: black

Dimensions & Weight

Length: 502 mm / 119.8 in

Width: 137 mm / 5.4 in

Height (head horizontal): 326 mm / 12.8 in





Weight

N.W: 11.2 kg

G.W: 13.5 kg

ACCESSORIES

These items are packed together with the projector:

Name	Quantity	Unit	Remark
 USER MANUAL This manual	1	Pcs	Paper
 power cord Power cable	1	Pcs	1.5m
 DMX CABLE XLR cable	1	Pc	1.5m
 SAFETY CORD Safety cord	1	Pc	
 BRACKET	1	Pc	

